

Better Duct Systems for Home Heating and Cooling



Duct systems used in forced-air space-conditioning systems are a vital element in home energy efficiency. How well a system works makes a big difference in the cost and the effectiveness of heating and cooling a home. At the same time, a duct system that is poorly designed or maintained can have a detrimental effect on the health of the people who live in the house, through the unintended distribution of indoor air pollution.

This brochure is intended to provide you with a working knowledge of residential heating and cooling duct systems. This includes an understanding of the major issues concerning efficiency, comfort, health and safety, as well as practical tips on installation and repair of duct systems. If you are a contractor, system designer, or heating/cooling professional, this information can help make your customers' lives more comfortable, safe, and energy efficient.¹ If you are a homeowner, it will allow you to work with a professional to upgrade the efficiency of your home's heating and cooling system.

Energy Losses and Their Costs

The purpose of a space-conditioning duct system is to convey heated or cooled air from the central furnace, heat pump, or air

¹The information in this brochure is condensed from a more detailed manual entitled *Better Duct Systems for Home Heating and Cooling*. A shorter consumer-oriented guide, *Improving the Efficiency of Your Duct System*, is also available. Both can be accessed at www.eere.energy.gov/buildings/info/publications.html.

conditioner to the rooms where it is needed. Typical systems with ducts in attics or crawl spaces lose from 25% to 40% of the heating or cooling energy that passes through them. In an era of increasing concern for energy efficiency, this is no longer acceptable.

Duct systems lose energy in two main ways: by air leakage through small cracks and seams and by conduction of heat through the duct wall. In addition, how the various systems and equipment interact has an effect on how well the ducts perform.

Air Leakage

Ducts lose energy when air leaks into or out of them. Sometimes this leakage is from holes in the ducts or from poorly connected duct joints. Even if the ducts are sealed, their operation can cause the house itself to leak more air because of differences in air pressure in various zones of the house.

Heat Conduction

Duct systems also lose energy when the warm or cool air they contain heats or cools the duct walls, which in turn heats or cools the air outside the ducts. In winter, ducts that are in an attic or vented crawl space that is nearly as cold as the outdoors lose this heat completely through the duct wall. If the ducts are in a basement, some of this lost heat may be recaptured as it warms the basement ceiling enough to reduce heat loss from the house. In summer, ducts gain heat from warm surrounding spaces, detracting from the air conditioner's ability to cool the house.

Energy Savings

How much can you save by fixing a duct system or by installing it correctly in the first place? Let's consider two benchmark cases, one in a cold climate (Chicago, Illinois) and the other in a hot, humid climate (Orlando, Florida). We'll suppose that in each case the ducts are in a location typical of the region—a crawl space in Chicago, the attic in Florida—and that their size and insulation

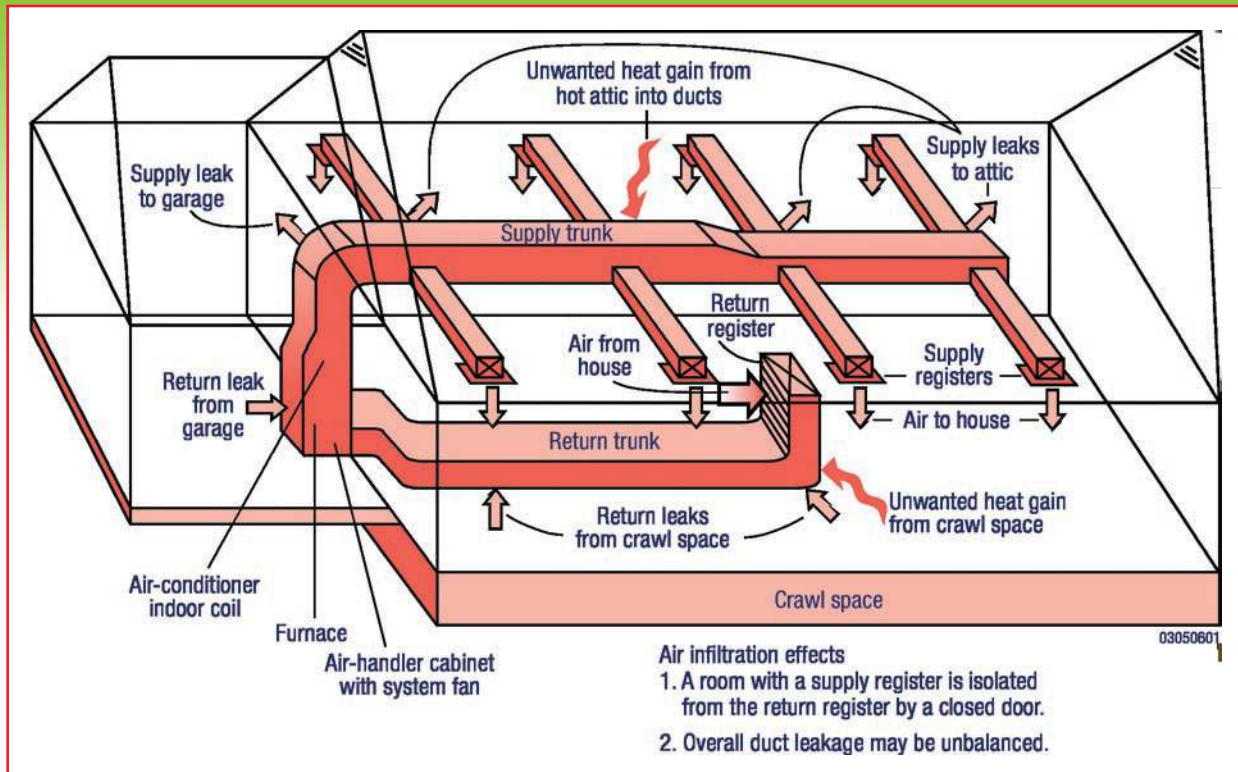

A common type of home duct system, showing energy flows and losses.

- Air infiltration effects**
1. A room with a supply register is isolated from the return register by a closed door.
 2. Overall duct leakage may be unbalanced.

level are also typical. Furthermore, we'll assume that they leak about as much as an average duct system.²

With these parameters, ASHRAE Standard 152³ can be used to calculate an expected average efficiency⁴ of the duct system over an entire heating or cooling season. The results are as follows:

- Chicago house: 63% for heating, 83% for cooling
- Orlando house: 74% for heating, 65% for cooling.

Even within a given climate region, different homes and lifestyles will have different ratios of heating to cooling. However, as a

²This assumes that the ducts are insulated to R-4 and have 15% leakage on each side (supply and return). This leakage level may sound high, but it is a couple of percent less than what was found in a recent national laboratory study.

³ASHRAE Standard 152 is a nationally standardized method for measuring duct efficiency, developed by the American Society of Heating, Refrigerating and Air-Conditioning Engineers, Inc.

⁴Duct efficiency (more precisely, "thermal distribution efficiency") is calculated as the ratio of (a) the fuel energy that would be needed by the system if it had perfect, loss-free ducts to (b) the fuel energy needed by the actual system with the as-found ducts. This definition accounts for system interactions.

benchmark, let us assume that in Chicago three-quarters of the energy requirement of the house is for heating, whereas in Orlando three-quarters is for cooling. The average duct efficiency will then be 67% in either location. In these typical cases, then, one-third of the energy given to the ducts is lost before it gets to the living space.

How much better can we do? A reasonable target for a duct retrofit would be to reduce the leakage by two-thirds—to 5% of the system fan flow on each side of the duct system—and increase the insulation level to R-8. This would result in the following duct efficiency levels:

- Chicago house: 81% for heating, 90% for cooling
- Orlando house: 86% for heating, 82% for cooling.

Using the same assumptions as above, this results in an average duct efficiency of 83% in either location.

With the original ducts, the equipment must provide 150 units of comfort in order to deliver 100 units of heating or cooling comfort to the house, because only two-thirds (67%) of that comfort makes

it to the living space. With the repaired ducts, the equipment only needs to provide 120 units of comfort heating or cooling to get 100 units (83% of 120) into the house. Thus, the load on the equipment is reduced by 30 units, which is 20% of the original requirement. The cost of running the equipment also will be reduced by 20% over a heating or cooling season.



When placed in a home's conditioned space, ducts can easily blend into the décor.

In new construction, ducts can be placed within the conditioned space. If done in a manner that leaves no hidden leakage paths to the outside, duct efficiency of 100% is possible. In this case, all the heating or cooling provided by the equipment would get to the living space, so the energy and cost savings compared with a “business as usual” system would be 50 units out of the original 150, or 33%.

These examples are, of course, only benchmarks. Your results may vary. The following are some factors that can increase or decrease the savings.

Percent savings may be greater for

- more severe climates (e.g., Minneapolis or Miami)
- original duct system leakage greater than the benchmark
- leakage predominantly in the supply ducts
- original ducts uninsulated or insulated less than R-4.

Percent savings may be less for

- more moderate climates (e.g., Washington, D.C.)
- ducts located in a basement or similar protected zone

- original duct leakage less than the benchmark
- leakage predominantly in the return ducts
- original ducts insulated more than R-4.

System Interactions

Duct energy losses and equipment inefficiencies can work together to give surprisingly low overall system efficiency. When a furnace meeting the current national standards (78% Annual Fuel Utilization Efficiency) is combined with a typical duct system installed in a vented attic or open crawlspace (60%–75% seasonal efficiency), only about half the heating value of the fuel will make it into the house!

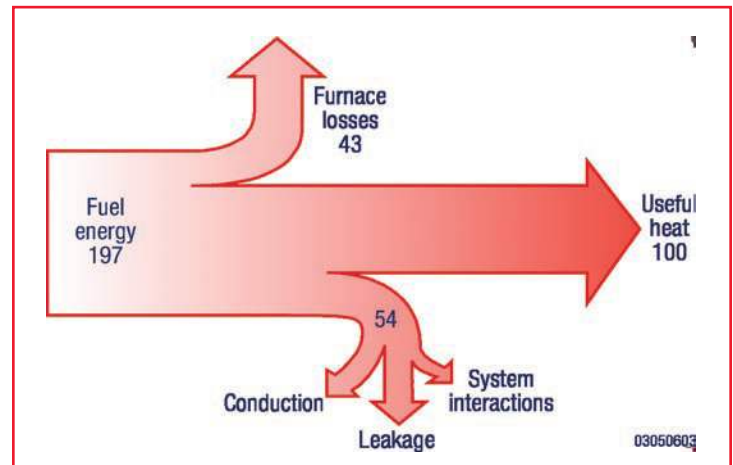

Heat losses from the furnace and the ducts can easily add up to half the energy value of the fuel that is consumed for heating.

Heat pumps and air conditioners display the same general trend as furnaces, although the calculation is somewhat more involved. Two or more energy losses, each of which might seem “not too bad” in itself, can add up to a very disappointing result. Ducts are too often “out of sight, out of mind.” The combined inefficiency of equipment and ducts is the prominent system interaction, but more subtle interactions can either lessen its impact or make it worse.

Thermal Regain — In most houses in the United States, duct systems are located in a space that is not heated or cooled. If this unconditioned space is not vented, then heat lost from the ducts may warm that space significantly. This increase in temperature retards heat loss from the adjacent conditioned living space. Heating of the zone also retards further heat conduction through

the duct walls themselves. These benefits can soften the energy penalty of the losses because some of the lost heat is, in effect, recovered. This is called thermal regain.

Locations with the highest thermal regain are the best places to install ducts. When located within the conditioned space, ducts have 100% regain because the lost heat is used. Unvented, uninsulated basements and crawl spaces have intermediate merit as locations for ducts, because about half the heating or cooling value of thermal loss is regained. Other duct locations, such as vented crawl spaces, attics, and exterior walls have regain factors ranging from 30% down to essentially zero and should be avoided if possible.

Equipment Efficiency — Some types of equipment, such as heat pumps and variable-capacity air conditioners, might suffer a loss of efficiency because of a poorly performing duct system, and this penalty is added to the energy losses in the duct system. Installing a variable-capacity furnace in a poorly insulated duct system can cause an already mediocre duct efficiency to drop off even further. Because the furnace is running at low capacity, heated air spends

more time in the ducts and can, therefore, cool down more before it is delivered to the living space. The lesson here is that if you are going to use premium equipment, you should also have premium ducts.

Pressure Effects — When in operation, the central air-handler fan often changes the distribution of pressures within the house. Thus, for example, a bedroom could have pressure higher than the living room. These pressure changes may affect the rate at which outdoor air infiltrates into the home, usually increasing the heating or cooling load.

Health, Safety, and Comfort Issues in Residential Ducts

Pressure changes caused by the air-handler fan can affect the health of the home's occupants through the unintended distribution of indoor air pollution. Room pressures can also be influenced by the various exhaust fans in the house (bathroom fans, vented range hoods, clothes dryers). Therefore, be sure to consider the combined operation of all air movers in the house when assessing the potential for health and safety problems.

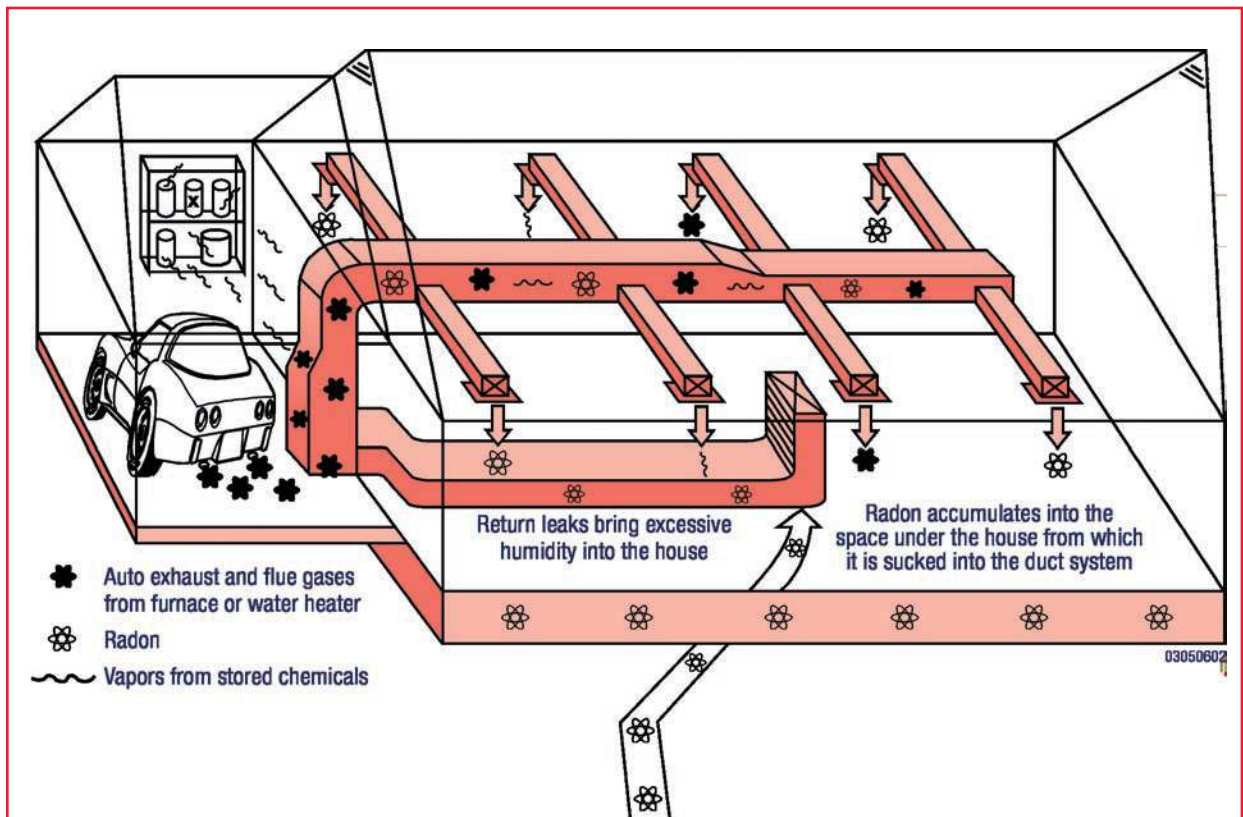

Safety, health, and comfort can be detrimentally affected by duct leakage.

The most common health problems associated with ducts arise from the induction of harmful gases, vapors, or particulates into the living space in concentrations that are unhealthy, but not immediately life-threatening. These contaminants can include flue gases from furnaces and water heaters, fumes from stored chemicals, and radon (a radioactive gas that comes from the ground).

Potentially lethal concentrations of carbon monoxide gas may be pulled into the living space from combustion appliances or exhaust from a car left running in the garage. Severe depressurization caused by leaky return ducts can also suck a flame out of a water heater, an obvious fire hazard on water heaters not equipped with a flame-rollout protective device. These more severe situations are not particularly common. However, professionals cannot afford to ignore their possible presence, because when these problems do occur, they are very serious.

The two main approaches to fixing such problems are to remove the source of contaminants and to seal the ducts, especially on the return side. Sometimes, it may be helpful to provide outside pressure relief or to repair or modify the equipment.

In humid climates, high indoor humidity is one of the most serious comfort problems during the cooling season. Often made worse by leaky ducts, high humidity can result in mold growth, mildew, and wood rot. In addition to damaging the appearance or the structural integrity of the building, these organisms can affect the health of the occupants if they become airborne. Poor humidity control is especially likely when the air is moist and temperature levels are moderate.

When ducts are repaired, rooms at the end of long ducts tend to become much more comfortable: warmer in winter and cooler in summer. Customers notice this immediate improvement and often consider this benefit alone to be worth the entire cost of the repair work.

The Golden Opportunity in Ducts

In the United States, ducted heating and cooling systems are installed in about 90% of new homes. The prevalence of forced-air systems provides several “golden opportunities” for contrac-



In this photo, a Building America staff member performs a duct blaster test to measure the impact of duct leakage on whole-house performance.

tors and builders to provide quality, reliable service to homeowners. A golden opportunity is a situation in which a service call to repair ducts provides exceptionally large reductions in fuel costs, increased comfort, enhanced safety, or other forms of customer benefits.

One such golden opportunity is the installation of heat-pump systems. In moderate and cold climates, heat pumps rely on electric resistance backup heat at the lowest outdoor temperatures, at which the compressor cannot deliver enough heat to meet the load. Improved duct efficiency reduces the amount of backup heat that the unit must provide. This improves the delivered capacity of the heat pump because more of the heating energy is delivered to the space rather than to the environment outside the home.

Still another golden opportunity occurs in the southern United States. Here, customers often complain that the air-conditioning system is not providing adequate cooling. The usual response is to install a larger unit. However, the real culprit is often the attic duct system. A better solution is to repair the leaking ducts and insulate them, which will not only provide a more comfortable home environment, but will probably save enough energy to pay back the repair cost several times over the life of the equipment.

From the point of view of the heating, ventilation, and air-conditioning contractor, the single best opportunity to interest a customer in duct renovation occurs when a furnace, heat pump, or air conditioner needs to be replaced. Because the contractor is already on site, the costs of finding a customer and traveling to the job are already paid.

Also, the best choice of replacement unit will often be influenced by the condition of the duct system. This provides three opportunities:

- upgraded equipment efficiency, with lower fuel costs
- better duct performance, with still-lower fuel costs and improved thermal comfort
- reduction in size and cost of the replacement equipment.

New construction offers many options in the design details of a duct system. These choices include location of the duct system within the building, the type of system layout, and the level of sealing and insulation to be employed. Placing the ducts in the conditioned space is the most efficient choice—energy losses can be eliminated and health and safety problems are unlikely to arise.

However, at least four impediments stand in the way of widespread use of conditioned-space ductwork: (1) difficulty of hiding ductwork, (2) perceived extra cost, (3) need for the building designer to get involved with the details of duct design, and (4) altered scheduling of trades on the job.

If any of these difficulties prevent the placement of ducts in the conditioned space, the next best practices should be considered. Good practice has the following elements:

- design the total heating and cooling system using a reliable method, such as that embodied in the Air Conditioning Contractors of America (ACCA) Manuals J, S, and D. An additional ACCA manual, “Duct Diagnostics and Repair,” discusses in greater detail the issues covered in this brochure
- minimize the surface area of ducts outside the conditioned space through good routing, use of low-loss fittings, and (where feasible) placement of registers near interior walls with the air handler centrally located in an interior closet

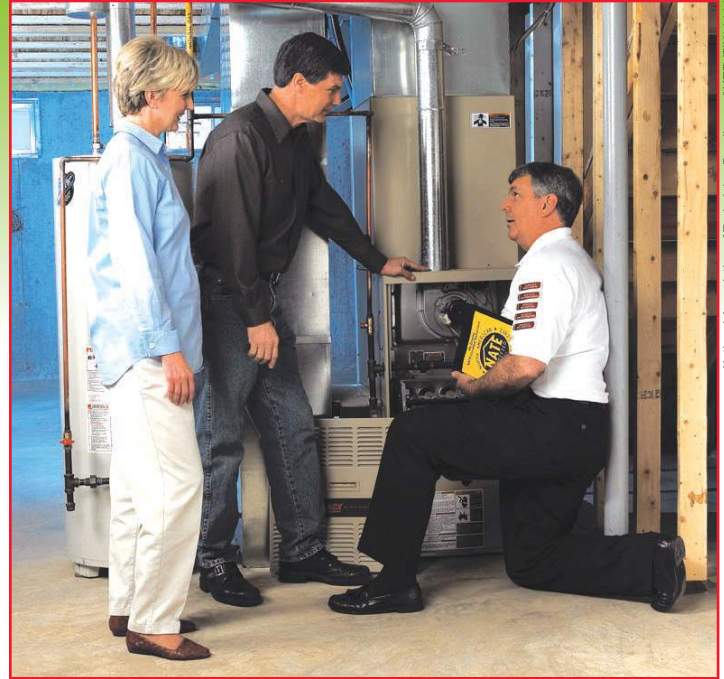

A trained duct technician can help homeowners save money by maintaining an energy-efficient heating and cooling system.

- specify suitably low levels of duct air leakage and include a post-installation leakage test in the construction plan. Air leakage to the outside should never exceed 5% of total air flow on either the supply or return side
- insulate ducts outside the conditioned space, preferably to R-8.

By combining these elements of good practice, duct energy losses can be reduced to a maximum of 20% of the underlying heating and cooling loads.

The ACCA Manuals J, S, and D are used for designing total heating and cooling systems (see References section). The process begins with a load calculation using ACCA Manual J. Manual S uses the load information to size the heating and cooling equipment. Manual D uses the load and equipment information to size the ducts.

Testing and Diagnosing Duct Systems

Visual inspection can reveal some flaws, but many poorly performing duct systems look just fine. This is where testing comes in. The following are some guidelines for testing and diagnosing duct systems.

Step One — Inspect the Duct System

Evaluating a duct system's efficiency begins with visual inspection. Here are some things to check for:

- disconnected ducts near registers and where runouts connect with trunk ducts
- excessive leaking where some part of the building is used as a duct (panned joists, vertical chases, and the like)
- uninsulated ductwork outside the conditioned space. In the case of attic ducts, consider adding R-value even if the ducts are insulated.

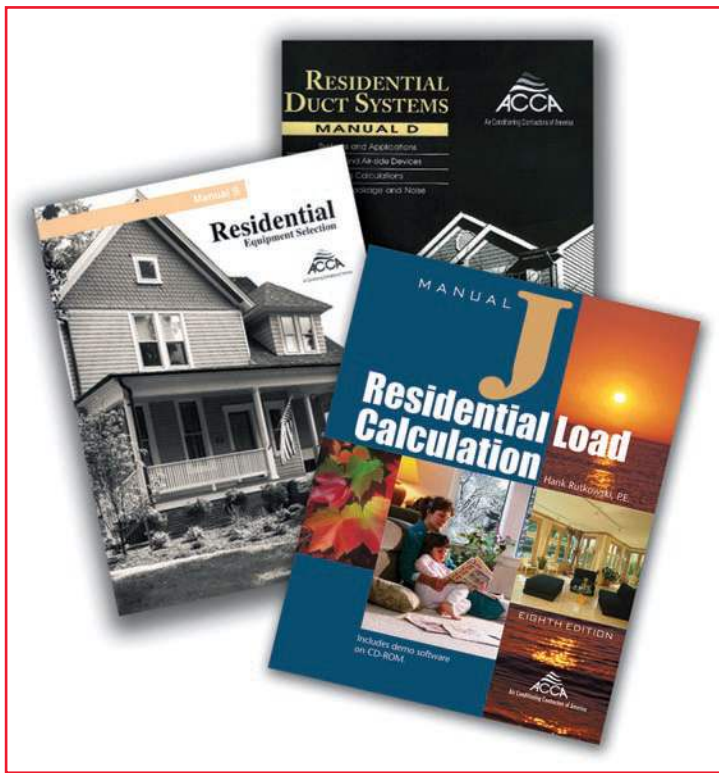

The ACCA manuals provide guidelines for designing heating and cooling systems.

Step Two — Test for Duct Leakage

Duct leakage tests require specialized equipment. At a minimum, the contractor needs a duct blower (adjustable calibrated fan) and a digital manometer (pressure gauge).

In the most basic duct leakage test, the duct blower is attached to the duct system at a large register or at the air handler, and all other registers are sealed. The duct-blower fan is then turned on, and its speed is adjusted until the pressure in the ducts reaches some standard value. The amount of airflow needed to reach this

pressure is a measure of the extent of leakage in the ducts. Variations on this technique can obtain more detailed information, such as, which side of the duct system (supply or return) leaks more and how much of the leakage is to the outside.

Step Three — Measure the System Airflow Rate

Measuring airflow rate at the system fan is nearly as important as measuring duct leakage. The efficiency of the duct system depends not on duct leakage alone, but on duct leakage as a fraction of fan flow. Another equally important reason is that low fan flow is one of the major causes of poor air-conditioner performance. Whatever the problem that caused the original call for help, it will usually benefit both the contractor and the customer if all problems besetting the system can be fixed in the same service call.

Airflow in ducts can be measured by several methods. A recent invention called the flow plate speeds up this measurement task and is usually accurate to within 7% of the true airflow rate.

Step Four — Determine What Actions to Take

Sometimes, what needs to be done is obvious. At other times, the big question is “How much effort should be put into duct repair?” Seldom does it pay to reduce duct energy losses all the way to zero. Three possible ways to make the decision are rules of thumb, program guidelines, and use of a standard to estimate the benefits of various corrective actions.

Rules of Thumb — These are very rough attempts to cover a wide range of cases, but the following suggestions can be adopted when better methods are not available:

Rule 1. Reduce duct leakage until the total duct leakage at 25 pascals⁵ pressure is less than 10% of the system fan flow rate.

Rule 2. Add R-8 insulation to any uninsulated ducts in unconditioned spaces and to attic ducts that currently have only R-4.

Program Guidelines — Residential energy efficiency programs run by federal, state, and private-sector agencies are increasingly including duct efficiency in their portfolios of system upgrades. In the interest of simplicity, these programs often provide their own guidelines to be used in assessing the need for duct repairs.

⁵A pascal is a unit of measure that equals one newton per square meter.

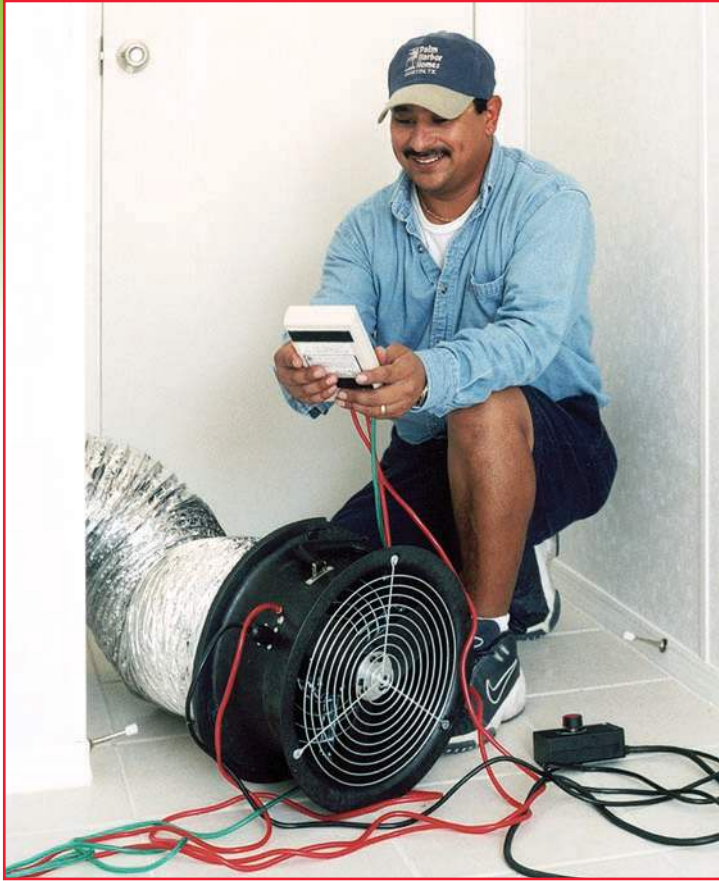

Charlie Castilleja/PV08008

Duct leakage can be tested using an adjustable fan and a digital pressure gauge.

Standards — ASHRAE Standard 152 provides a means for determining the efficiency of residential duct systems in the heating and cooling modes. Although air leakage is a major cause of duct inefficiency, other factors such as heat conduction through the duct walls, influence of the system fan on pressures within the house, and partial regain of lost heat are also important. Standard 152 takes these factors into account. An Internet web site (<http://ducts.lbl.gov>) has an easy-to-use calculator. The user enters information about the house, the heating and cooling equipment, the system airflow rate, the duct leakage, and the name of the city nearest the site. The calculator can then predict duct efficiencies for the system.

It's free, it's fun (at least for anyone who likes to play with numbers), and it can quickly show the effects of duct location, air leakage, and insulation level on duct efficiency.

Installation and Repair of Duct Systems

When making duct repairs, the contractor has to work with the materials at hand. Fortunately, the state of the art in duct repair is advancing rapidly.

“Is it OK to use duct tape?” That’s one of the first questions asked in a duct repair class. The answer is simple: “A duct repair should last as long as the ducts themselves.” Consequently, that rules out most types of duct tape that one can normally purchase for duct sealing.

The fabric-backed, rubber-based adhesive duct tape that can be bought at the neighborhood hardware store will fail rapidly when subjected to the conditions of temperature, humidity, and pressure normally encountered in ducts. More advanced tapes, specifically designed for duct repair, are coming on the market, and quite possibly some may stand the test of time. However, the current stance should be, “When in doubt, don’t use it.”

So, what do we recommend? This depends on the material from which the duct is constructed, but the best general answer is a special UL Listed (not just UL Classified) adhesive paste called mastic (preferably one that is specially formulated for duct repair). UL Classified mastic tests mainly for problems relating to fire, whereas UL Listed mastic tests for many things, of which the most important for our purposes is co-adhesion (holding ability and elasticity).

Sealing — The proper sealing procedure for smaller leaks (less than 1/4 in. wide) is to apply a bead of mastic alone. For larger gaps, first apply a layer of mastic at least 3 in. wide along the entire crack length. Then embed a layer of fiberglass mesh at least 2 in. wide in the mastic, and then apply a final layer of mastic over the mesh. Proper technique is best learned from an experienced practitioner. The process is not difficult, though sometimes it is awkward.

When repairing ducts, plan the job. Remember that the tasks of sealing and insulating the ducts are equally important. A well-planned job will include the following steps:

- sketch the duct system
- evaluate the fundamental integrity of the duct system
- seal the ducts
- insulate the ducts
- correct zone pressure imbalance problems.

After doing an evaluation of the duct system, it may be advisable to replace one or more duct sections. This is especially true in the following situations:

- the structural integrity of the duct system has been seriously compromised
- parts of the building have been used as ducts in such a manner as to make sealing excessively difficult or of questionable value
- replacement is less costly than repair.

The decision to repair or replace will often be strongly influenced by economics. For example, flex duct is relatively quick and cheap to install; sheet metal and duct board are more involved. Once replacements have been made, the ducts can be sealed.

Duct sealing can be divided into two portions:

- repairing large leaks found during the general inspection
- finding and repairing other leaks.

Large leaks are usually disconnected ducts. Sometimes the physical reconnection will be relatively simple. At other times, the disconnect will be caused by failure of some component, which will have to be replaced. Once the large leak is repaired, the total leakage around the remaining cracks and spaces in the joint can be treated as smaller leaks, along with any previously found holes that are not disconnects.

After all known leaks are sealed, it's time to seek out the less obvious ones. This is vital because most systems have sections that are not easy to see, and leaks can be easily overlooked.

A small hand-held smoke generator is a handy tool for this job. Introduce the smoke at the inlet side of the duct-blower fan and



Repair of a platform return. Before (top): Note the cracks and gaps along the edges and joints. After (right): The same platform return after it has been sealed from the inside using mastic.



watch to see where it exits. Be certain, of course, that the smoke used is of acceptably low toxicity and that the house is well ventilated during and after the test.

Insulating — Insulating the ducts is the second part of the duct-repair job. Duct board and flexible ducts are usually provided with effective R-values ranging from R4 to R8.

Sheet-metal ducts may be insulated or uninsulated. In either case, additional insulation can be added in the form of duct wrap.

Pressure Testing — Because pressure imbalances can have serious health and safety implications in some systems, it is imperative that technicians learn proper pressure-testing techniques. Zone pressurization testing has two distinct goals. The first, and most important, is testing for worst-case depressurization of a room or zone containing combustion appliances. As a rule, such an area of the building should not be allowed to depressurize more than 3 pascals relative to the outside.

The second goal is to look for pressure differences between zones that can be separated by closing a door. Pressure differences of more than 2 to 3 pascals should be relieved by providing an adequate airflow path between the zones.

Training — Any duct retrofit business worthy of the name will require its technicians to receive hands-on training at a good duct-repair school. Periodic updating of technique is also highly recommended. Aside from the basic hand-sealing technique,

practitioners should keep abreast of new technologies of automatic duct sealing. One of these methods makes use of aerosol sealants blown into the duct with a computer-controlled adjustable-speed fan.

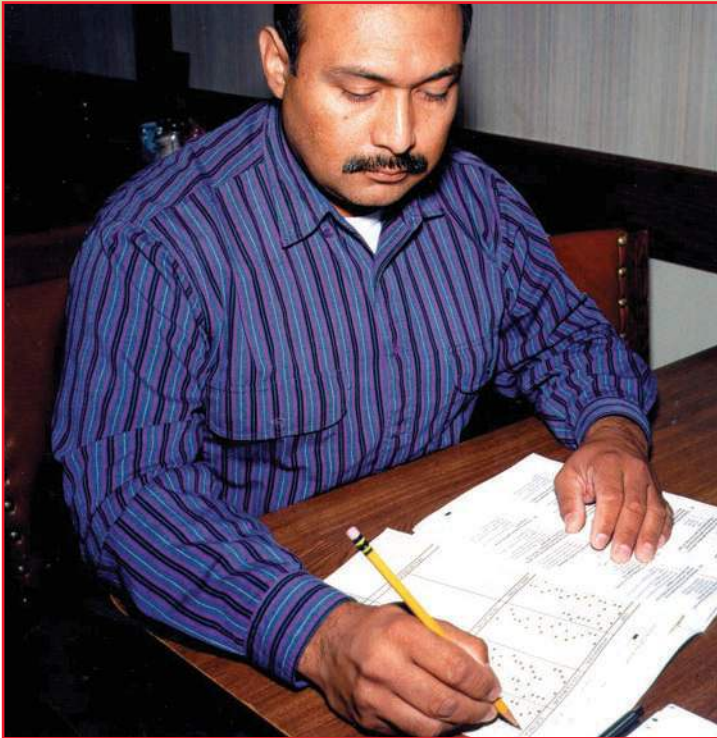

National Association of Technician Excellence (NATE)/PIX11112

Reputable heating and cooling businesses will require their duct technicians to attend training courses to stay informed of the latest techniques.

We hope that this brochure helps you to better understand home heating and cooling ducts and the problems that can arise, as well as their solutions. The following section provides a list of resources for additional information pertaining to ducts.

References, Resources, and Additional Information

This brochure has been condensed from a larger publication. See page 1 of this brochure for information on how to get a copy. The following references may also be useful:

Publications

Duct Basics

Home Energy Magazine. 1993. Special Issue — Ducts Rediscovered. September/October.

This Old House: Heating, Ventilation, and Air Conditioning, by Richard Trethewey. Little, Brown. 1994.

Right-Size Heating and Cooling Equipment. January 2002. U.S. Department of Energy, Office of Building Technology, State and Community Programs, DOE/GO-102002-1490.

Health, Safety, and Comfort Issues in Residential Ducts
Home Energy Magazine. 1997. Special Issue — Health and Safety. November/December.

Fire Safety Standards

NFPA-31. Standard for the Installation of Oil-Burning Equipment

NFPA-54. National Fuel Gas Code

NFPA-211. Chimneys, Fireplaces, Vents, and Solid Fuel-Burning Appliances

National Fire Protection Association, 1 Batterymarch Park, Quincy, Massachusetts 02269-9101.

Customer Benefits from Better Duct Systems

A Builder's Guide to Placement of Ducts and HVAC Equipment in Conditioned Spaces. NAHB Research Center, Inc., 400 Prince George's Blvd., Upper Marlboro, Maryland 20774.

Designing and Building Interior Duct Systems. Florida Solar Energy Center, 1679 Clearlake Road, Cocoa, Florida 32922.

Duct Design Strategies

Delivering Tons to the Register: Energy Efficient Design and Operation of Residential Cooling Systems, by J. Siegel, I. Walker, and M. Sherman. Proceedings of the 2000 ACEEE Summer Study on Energy Efficiency in Buildings. Vol. 1, pp. 295–306.

Energy Efficient Design of New Low-Rise Residential Buildings. Standard 90.2-1993. American Society of Heating, Refrigerating, and Air-Conditioning Engineers, 1791 Tullie Circle, N.E., Atlanta, Georgia 30329.

Residential Design Manuals

Manual J: Residential Load Calculation

Manual S: Residential Equipment Selection

Manual D: Residential Duct Systems

Air Conditioning Contractors of America, 2800 Shirlington Road, Suite 300, Arlington, Virginia 22206.

Testing and Diagnosing Duct Systems

ASHRAE Standard 152P: Method of Test for Determining the Design and Seasonal Efficiencies of Residential Thermal Distribution Systems. American Society of Heating, Refrigerating, and Air Conditioning Engineers, 1791 Tullie Circle, N.E., Atlanta, Georgia 30329.

A New Device for Field Measurement of Air Handler Flows, by L. Palmiter and P. W. Francisco. Proceedings of the 2000 ACEEE Summer Study on Energy Efficiency in Buildings. Vol. 1, pp. 197–206.

Installation and Repair of Duct Systems

A Guide to Insulated Air Duct Systems. North American Insulation Manufacturers Association, 44 Canal Center Plaza, Suite 310, Alexandria, Virginia 22314.

Flexible Duct Performance and Installations Standards, 3rd Edition. Air Diffusion Council, 1000 E. Woodfield Road, Suite 102, Schaumburg, Illinois 60173-5921.

Installation Standards for Residential Heating and Air Conditioning Systems. Sheet Metal and Air Conditioning Contractors National Association, Inc., 4201 Lafayette Center Drive, Chantilly, Virginia 20151-1209.

Residential Duct Diagnostics and Repair. Air Conditioning Contractors of America, 2300 Shirlington Road, Suite 300, Arlington, Virginia 22206.

Residential Field Testing of an Aerosol-Based Technology for Sealing Ductwork, by M. P. Modera, D. Dickerhoff, and O. Nilssen. Proceedings of the 1996 ACEEE Summer Study on Energy Efficiency in Buildings. Vol. 1, pp. 169–176.

Stopping Duct Quacks: Longevity of Residential Duct Sealants, by M. Sherman, I. Walker, and D. Dickerhoff. Proceedings of the 2000 ACEEE Summer Study on Energy Efficiency in Buildings. Vol. 1, pp. 273–284.

Web Links

Home Energy Magazine
www.homeenergy.org/

An Introduction to Residential Duct Systems
ducts.lbl.gov/

Air Conditioning Contractors of America
www.acca.org/

Affordable Comfort, Inc.
www.affordablecomfort.org/

North American Technician Excellence
www.natex.org/

United States Environmental Protection Agency Energy Star
energystar.gov/ducts/

A Strong Energy Portfolio for a Strong America

Energy efficiency and clean, renewable energy will mean a stronger economy, a cleaner environment, and greater energy independence for America. Working with a wide array of state, community, industry, and university partners, the U.S. Department of Energy's Office of Energy Efficiency and Renewable Energy invests in a diverse portfolio of energy technologies.

Research and Development of Buildings

Our nation's buildings consume more energy than any other sector of the U.S. economy, including transportation and industry. Fortunately, the opportunities to reduce building energy use—and the associated environmental impacts—are significant.

DOE's Building Technologies Program works to improve the energy efficiency of our nation's buildings through innovative new technologies and better building practices. The program focuses on two key areas:

• Emerging Technologies

Research and development of the next generation of energy-efficient components, materials, and equipment

• Technology Integration

Integration of new technologies with innovative building methods to optimize building performance and savings

For more information contact:
EERE Information Center
1-877-EERE-INF (1-877-337-3463)
www.eere.energy.gov



U.S. Department of Energy
**Energy Efficiency
and Renewable Energy**

An electronic copy of this factsheet is available on the Building America Web site at www.buildingamerica.gov

Visit our Web sites at:

www.buildingamerica.gov

www.pathnet.org

www.energystar.gov



Building America Program

George S. James • New Construction • 202-586-9472 • fax: 202-586-8134 • e-mail: George.James@ee.doe.gov
Terry Logee • Existing Homes • 202-586-1689 • fax: 202-586-4617 • e-mail: terry.logee@ee.doe.gov
Lew Pratsch • Integrated Onsite Power • 202-586-1512 • fax: 202-586-8185 • e-mail: Lew.Pratsch@hq.doe.gov
Building America Program • Office of Building Technologies, EE-2J • U.S. Department of Energy • 1000 Independence Avenue, S.W. • Washington, D.C. 20585-0121 • www.buildingamerica.gov

Building Industry Research Alliance (BIRA)

Robert Hammon • ConSol • 7407 Tam O'Shanter Drive #200 • Stockton, CA 95210-3370 • 209-473-5000 • fax: 209-474-0817 • e-mail: Rob@consol.ws • www.bira.ws

Building Science Consortium (BSC)

Betsy Pettit • Building Science Consortium (BSC) • 70 Main Street • Westford, MA 01886 • 978-589-5100 • fax: 978-589-5103 • e-mail: Betsy@buildingscience.com • www.buildingscience.com

Consortium for Advanced Residential Buildings (CARB)

Steven Winter • Steven Winter Associates, Inc. • 50 Washington Street • Norwalk, CT 06854 • 203-857-0200 • fax: 203-852-0741 • e-mail: swinter@swinter.com • www.carb-swa.com

Davis Energy Group

David Springer • Davis Energy Group • 123 C Street • Davis, CA 95616 • 530-753-1100 • fax: 530-753-4125 • e-mail: springer@davisenergy.com • deg@davisenergy.com • www.davisenergy.com/index.html

IBACOS Consortium

Brad Oberg • IBACOS Consortium • 2214 Liberty Avenue • Pittsburgh, PA 15222 • 412-765-3664 • fax: 412-765-3738 • e-mail: boberg@ibacos.com • www.ibacos.com

Industrialized Housing Partnership (IHP)

Subrato Chandra • Florida Solar Energy Center • 1679 Clearlake Road • Cocoa, FL 32922 • 321-638-1412 • fax: 321-638-1439 • e-mail: subrato@fsec.ucf.edu • www.baihp.org

National Association of Home Builders (NAHB) Research Center

Tom Kenney • National Association of Home Builders (NAHB) Research Center • 400 Prince George's Boulevard • Upper Marlboro, MD 20774 • 301-430-6246 • fax: 301-430-6180 • toll-free: 800-638-8556 • www.nahbrc.org/

National Renewable Energy Laboratory

Ren Anderson • 1617 Cole Boulevard, MS-2722 • Golden, CO 80401 • 303-384-7433 • fax: 303-384-7540 • e-mail: ren_anderson@nrel.gov • www.nrel.gov

Tim Merrigan • 1617 Cole Boulevard, MS-2722 • Golden, CO 80401 • 303-384-7349 • fax: 303-384-7540 • e-mail: tim_merrigan@nrel.gov • www.nrel.gov

Oak Ridge National Laboratory

Pat M. Love • P.O. Box 2008 • One Bethel Valley Road • Oak Ridge, TN 37831 • 865-574-4346 • fax: 865-574-9331 • e-mail: lovepm@ornl.gov • www.ornl.gov

Produced for the U.S. Department of Energy (DOE) by the National Renewable Energy Laboratory, a DOE national laboratory.
November 2004 • DOE/GO-102004-1606

Printed with a renewable-source ink on paper containing at least 50% wastepaper, including 20% postconsumer waste.